











Fashion Bed Group

A Division of Leggett & Platt Incorporated

Parts List For Lenore Bed

BED CARTON	HEADBOARD CARTON				
<p>(10) HEADBOARD PANEL (11) FOOTBOARD PANEL</p> <p>PART #363901 HARDWARE BAG FOR FRAME ATTACHMENT</p> <p>(1) 1/4-20 X 2 1/4" COUNTER SUNK ALLEN HEAD SCREW - 4 (2) 1/4-20 X 1" FLAT ALLEN HEAD SCREW-4 (3) 5/8" (OD) FLAT METAL WASHER - 8 (4) 1/4" (ID) LOCK METAL WASHER - 8 (5) 1/4 - 20 HEX NUTS - 4 (6) ALLEN WRECH- 1 (7) OPEN END WRENCH - 1</p> <p>(8) LEG. EXTENSIONS - 2 # 363903 (9) PLASTIC GLIDES - 4 # 363904</p> <p>NOTE: GLIDES COME PRE-INSERTED</p>	<p>(10) HEADBOARD PANEL</p> <p>PART #363902 HARDWARE BAG FOR FRAME ATTACHMENT</p> <p>(1) 1/4-20 X 2 1/4" COUNTER SUNK ALLEN HEAD SCREW - 4 (3) 5/8" (OD) FLAT METAL WASHER - 4 (4) 1/4" (ID) LOCK METAL WASHER - 4 (5) 1/4 - 20 HEX NUTS - 4 (6) ALLEN WRENCH - 1 (7) OPEN END WRENCH - 1 (8) LEG. EXTENSIONS - 2 # 363903 (9) PLASTIC GLIDES - 2 # 363904</p> <p>NOTE: GLIDES COME PRE-INSERTED</p>	<p>1</p> 	<p>2</p> 	<p>3</p> 	<p>4</p> 
		<p>5</p> 	<p>6</p> 	<p>7</p> 	
		<p>8</p> 	<p>9</p> 		
		<p>10</p> 	<p>11</p> 		

PRODUCT FULLY ASSEMBLED

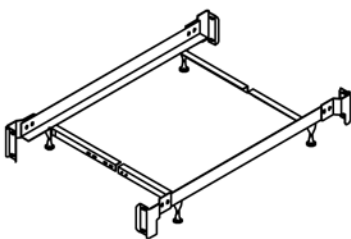
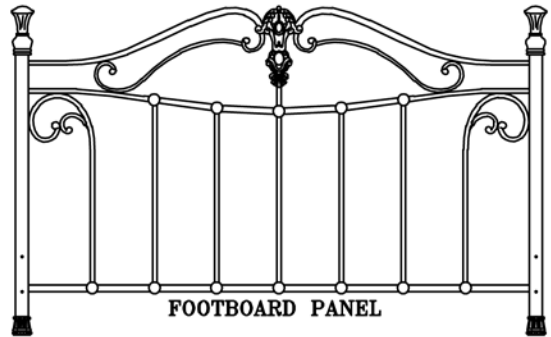
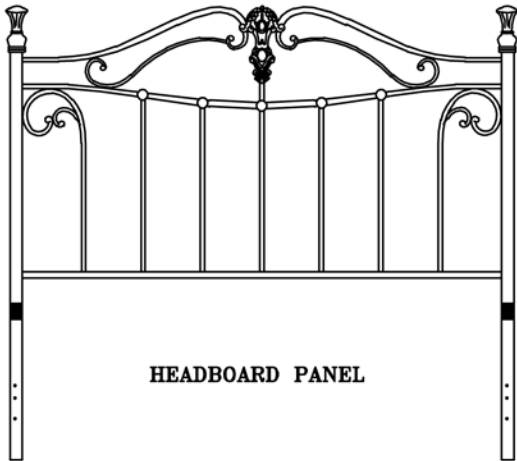

TWIN - FULL BED FRAME FULLY ASSEMBLED
NOTE: SEE INSTRUCTIONS INCLUDED IN FRAME CARTON FOR FRAME ASSEMBLY

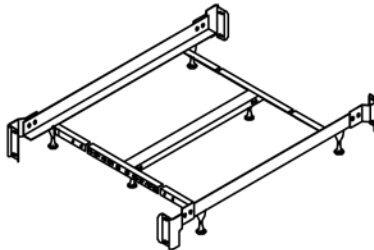

QUEEN - KING BED FRAME FULLY ASSEMBLED
NOTE: SEE INSTRUCTIONS INCLUDED IN FRAME CARTON FOR FRAME ASSEMBLY

Instruction Sheet

SAVE ALL PACKAGING MATERIALS UNTIL PRODUCT IS FULLY ASSEMBLED. HARDWARE AND SMALL PIECES MAY NOT BE SEEN AND BE ACCIDENTALLY DISCARDED WITH PACKAGING MATERIALS.

FIGURE 1

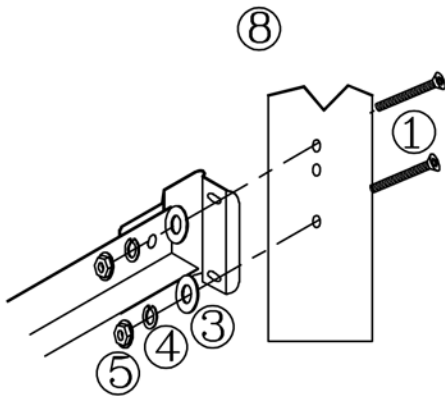
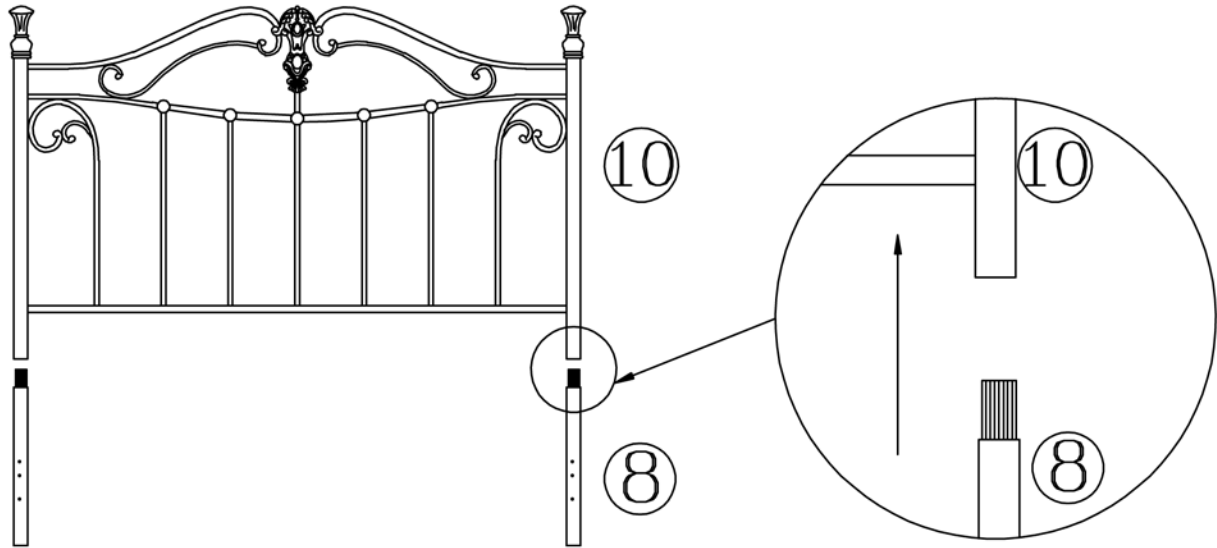

FIGURE 2

Step 1

- Align top reduction of extension legs (8) with bottom of headboard posts (10). (See Figure 1) Make sure the 3 holes on extension legs are perpendicular to headboard panel.
- Now carefully insert extension legs (8) into bottom of headboard post panel (10).

Step 2

- Place headboard and frame in desired location in room.
- Place 2 screws (1) through holes located in leg (8) (See Figure 2)
- Align bed frame bracket over screws.
- Place a flat metal washer (3) and lock washer (4) and then a nut (5) over on each screw. Hand, DO NOT TIGHTEN screws all the way. (See Figure 2)
- Repeat on other side of headboard.
- Tighten all screws securely using the Allen wrench (6) and open wrench (7).

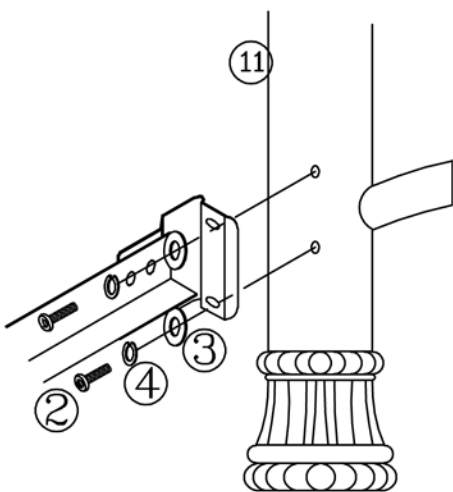

FIGURE 3

Step 3

- Position footboard panel (11) and align holes in the post with holes in the frame bracket. (See figure 3)
- Place a lock washer (4) and a flat washer (3) over on each screw (2). Insert through bracket and into post. Hand, DO NOT TIGHTEN screws all the way.
- Repeat on other side of footboard panel.
- Tighten all screws securely using the Allen wrench (6).